

HT-10KVDC

Dielectric Withstand Tester

0-14000 Volts DC Output

Instruction Manual

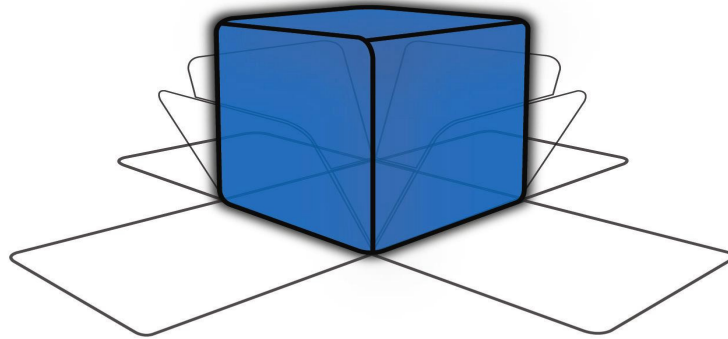

COMPLIANCE WEST_{USA}

Dear Customer:

Congratulations! Compliance West USA is proud to present you with your Dielectric Withstand Tester. Your instrument features a groundbreaking logic-controlled circuit design and ergonomic front panel, and represents the latest in high voltage laboratory testing.

To fully appreciate all the features of your new meter, we suggest that you take a few moments to review this manual. Compliance West USA stands by your instrument with a full one-year warranty and a loaner instrument policy. If the need arises, please don't hesitate to call on us.

Thank you for your trust and confidence.

Table of Contents

Initial Setup	2
An Introduction to Dielectric Withstand Testing with the HT-10KVDC.....	3
Leakage Test	3
High Voltage Dielectric Withstand Test.....	3
High Voltage Discharge	4
Introduction	5
Specifications	5
Operation.....	7
Setting up the HT-10KVDC.....	7
AC Line Voltage Requirements	7
Fuse Replacement	7
Front and Rear Panel Features	8
Initial Checkout Procedure.....	13
Setting up the HT-10KVDC for Laboratory Testing	13
Factory Settings.....	14
Adjustment of the Leakage Current Level	14
Adjustment of the High Voltage Ramp Time	15
Adjustment of the High Voltage Level	15
Adjustment of the High Voltage Test Duration.....	15
Setting the Voltage Ramp Switch	16
Setting the Test Timer Switch.....	16
Setting the Failure Shutdown Switch.....	16
Operating Techniques	16
Daily Operation Test.....	17
Testing Products.....	17
Test results	18
Hipot Pass.....	18
Red LED/Buzzer	18
Technical Assistance.....	21
Maintenance and Calibration	22
Service Information.....	22
General Maintenance	22
Calibration Access	22
Cleaning	23
Performance Test	23
Operation/Lamp Function Test.....	23
Calibration Procedure.....	24
Meter Calibration Adjustment	24

Section 0

Quick Start

For a quick look at the abilities of the HT-10KVDC, we are providing this quick start page, designed to get you up and running quickly. We recommend that you read the entire manual before using the HT-10KVDC to conduct actual testing.

Initial Setup

1. Remove the HT-10KVDC from its shipping carton and set it up on a bench. Plug it in to a correctly rated source of supply, using the supplied cordset. Turn it on using the switch on the rear panel.
2. Switch the Test Duration switch on the rear panel to the DEFEAT position.
3. Push the RESET Button, then push and hold the TEST Button. The output voltage will stay on while the TEST Button is pressed.
4. Set the voltage level using the Voltage knob on the front panel.
5. Let the TEST Button go; output voltage will drop to zero.
6. Plug the red lead into the Output Jack. Plug the black lead into the Return Jack.
7. Connect the Test Leads across the part to be tested. Push and hold the TEST Button. Watch the front panel lights for test results.

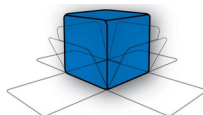

Section 1

An Introduction to Dielectric Withstand Testing with the HT-10KVDC

The dielectric withstand test is a test which is recognized by safety agencies worldwide as a valid criterion of safe assembly of end-use equipment. The HT-10KVDC is designed as a research instrument to determine the dielectric properties of component assemblies of end-use equipment. It applies a high-voltage potential between Output and Return test leads and monitors Leakage Current and watches for Dielectric Breakdown during the test. To aid in testing, the HT-10KVDC can be configured with or without voltage ramp time, with or without a test duration timer, and can be set to deliver high voltage after an arc has been detected to allow safety engineers to pinpoint the problem.

The dielectric withstand test involves high voltage and caution should be exercised when using the HT-10KVDC. The Return Jack on the front panel is connected to ground potential, and setups should be designed with this in mind, to guard against the operator contacting high voltage. Always make sure the return lead is firmly connected.

Leakage Test

The HT-10KVDC leakage test uses a separate low-frequency circuit to detect excessive current as a result of low impedance between the Output and Return jacks on the front panel. There is not a specific leakage current level pass/fail requirement at this time for most equipment. However, higher than normal leakage current on a particular sample may indicate an assembly or component problem in the circuit.

The leakage current is also monitored by the HT-10KVDC to ensure that excessive leakage does not keep the tester from developing full voltage required for the high voltage test. The HT-10KVDC will provide full voltage at any leakage current level up to 5 mA DC. The leakage current trip level is adjustable on the rear panel.

If the green Full Voltage LED lights and the test continues, the leakage current was below the amount set by the rear panel adjustment.

If the red Excess Leakage LED lights, the buzzer sounds, and the test is terminated, the leakage current was over the amount set by the rear panel adjustment.

High Voltage Dielectric Withstand Test

This test checks for insulation system breakdowns by applying a high voltage between the Output and Return jacks on the front panel. The HT-10KVDC uses a separate high-frequency circuit to detect arc breakdowns of greater than 100 nsec duration.

The duration of the test is controlled by the test time control on the back panel. The test time is counted from the time the Full Voltage LED is lit to the completion of the test. The timer may be defeated, allowing the test to continue for as long as the TEST Button is pressed. The minimum test time when the timer is defeated is one second.

If the green Hipot Pass LED lights, the test cycle has been successfully completed, meaning there was no dielectric breakdown,

If the red Hipot Fail LED lights, a breakdown arc has been detected.

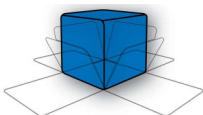

High Voltage Discharge

The HT-10KVDC has an internal rampdown circuit designed to discharge the high voltage after completion of the dielectric withstand test. The HT-10KVDC should remain connected to the circuit until the green "Hipot Pass" light or the red "Hipot Fail" light on the front panel is lit, and the output voltage, as indicated on the front panel meter, drops to a safe level. This indicates that the HT-10KVDC output voltage has discharged to a safe level and there is no energy stored in the circuit.

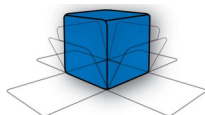

Section 2

Introduction

This manual contains complete operating, maintenance and calibration instructions for the Compliance West USA Model HT-10KVDC Dielectric Withstand Tester.

The instrument is a bench-type Dielectric Withstand Tester with DC Output, designed for laboratory testing of components and insulation systems.

The HT-10KVDC features automatic one button operation, with numerous safety features designed to protect the operator:

- The Return Lead is directly connected to ground potential for operator safety.
- The test can be immediately terminated at any time by pressing the RESET button.
- Before the test can commence, the unit must be armed by pressing the RESET Button. The test will not begin until the TEST Button is pushed.
- A non-defeatable rampdown circuit returns output voltage to safe levels before test termination. The Hipot Pass or Hipot Fail light will not light until voltage has been ramped down by the HT-10KVDC.
- If a failure is encountered, the high voltage output is disabled, a buzzer sounds, and any voltage stored in the equipment being tested is bled off by an internal rampdown circuit in the HT-10KVDC. Voltage discharge progress shown by front panel meter.
- The failure mode is shown by the front panel LEDs.

Testing features include:

- Voltage ramp, test time and leakage limit are settable.
- Voltage ramp and test duration timer are defeatable for specialized testing.
- Testing may be terminated or continued when a dielectric breakdown is detected.
- A 120kohm resistor is supplied on the rear panel for leakage current calibration.

Your Tester is warranted for a period of one year upon shipment of the instrument to the original purchaser.

Specifications

Specifications for the HT-10KVDC are listed in Table 2-1.

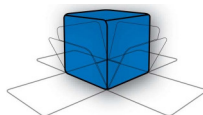

ELECTRICAL

Output	0-14000 volts DC
Leakage Current	1-5 mA
Pass/Fail Criteria:	
Leakage Current:	Pass/Fail point user adjustable.
Dielectric Breakdown:	Separate high frequency detection circuit for breakdown spike detection
Test Time:	User adjustable 1->60 sec., defeatable
Voltage Ramp-up Time:	User adjustable 1-5 sec., defeatable
Voltage Ramp-down Time:	Factory set 8 sec. maximum
Meter Accuracy	+/- 3 % full scale
Duty cycle	100 %
Test adjustments	Rear Panel: Ramp Time Test Time Leakage Limit Voltage Adjust Voltage Ramp ON/DEFEAT Timer Duration ON/DEFEAT Failure Shutdown ON/DEFEAT
 ENVIRONMENTAL	
Operating Temperature	15-40°C
Relative Humidity Range	0-90% non-condensing
 GENERAL	
Input power requirements	Model HT-10KVDC: 114-127 volts, 50/60 Hz
Weight	22 lbs.
RESET and TEST Lamp Type	Replace with type 73 14V lamp.
 SAFETY AGENCY TOPICS	
Transformer Output	< 500VA
Visual Indication of Voltage Output	Provided by front panel meter, directly connected to high voltage output
Failure Indication	Audible, provided by internal buzzer Visual, provided by red LEDs on front panel
Leakage Test	Test can be automatically terminated on failure Provided; 120Kohm calibration resistor provided on rear panel.

Table 2-1 HT-10KVDC Specifications



Section 3

Operation

This section describes how to set up and make measurements with the HT-10KVDC. We recommend that you read the entire section carefully so that you can use all of its features.

Setting up the HT-10KVDC

The HT-10KVDC is shipped in a special protective container that should prevent damage during shipping. The container should include the following:

- The HT-10KVDC Dielectric Withstand Tester
- A black 18 AWG Test Return Lead (Alligator Clip/Banana Plug ends)
- A red 18 AWG High Voltage Test Lead (Alligator Clip/High Voltage Plug ends)
- A Power Cord.
- This Instruction Manual

Use the original shipping container for subsequent shipping. If the original shipping container is not available, be sure that adequate protection is provided to prevent damage during shipment.

Remove the Tester from its container and place it on a test bench.

AC Line Voltage Requirements

Connect the HT-10KVDC only to the voltage source per the rating on the rear panel.

Fuse Replacement

There is a user-replaceable fuse (F1) located on the rear panel. The fuse rating is on the rear panel.

Use the following procedure to replace the fuse F1:

1. Turn the power switch to the O or off position.
2. Unplug the HT-10KVDC from the source of supply.
3. Remove the power cord from the HT-10KVDC.
4. Open the fuseholder door.
5. Replace the fuse with one of the correct rating.
6. Replace the fuseholder door and power inlet cord.

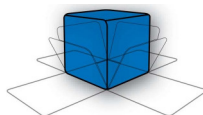

Front and Rear Panel Features

The front panel features of the HT-10KVDC are shown in Figure 3-1 and described in Table 3-1. The rear panel features of the HT-10KVDC are shown in Figure 3-2 and described in Table 3-2.

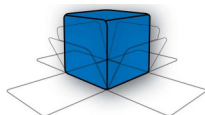

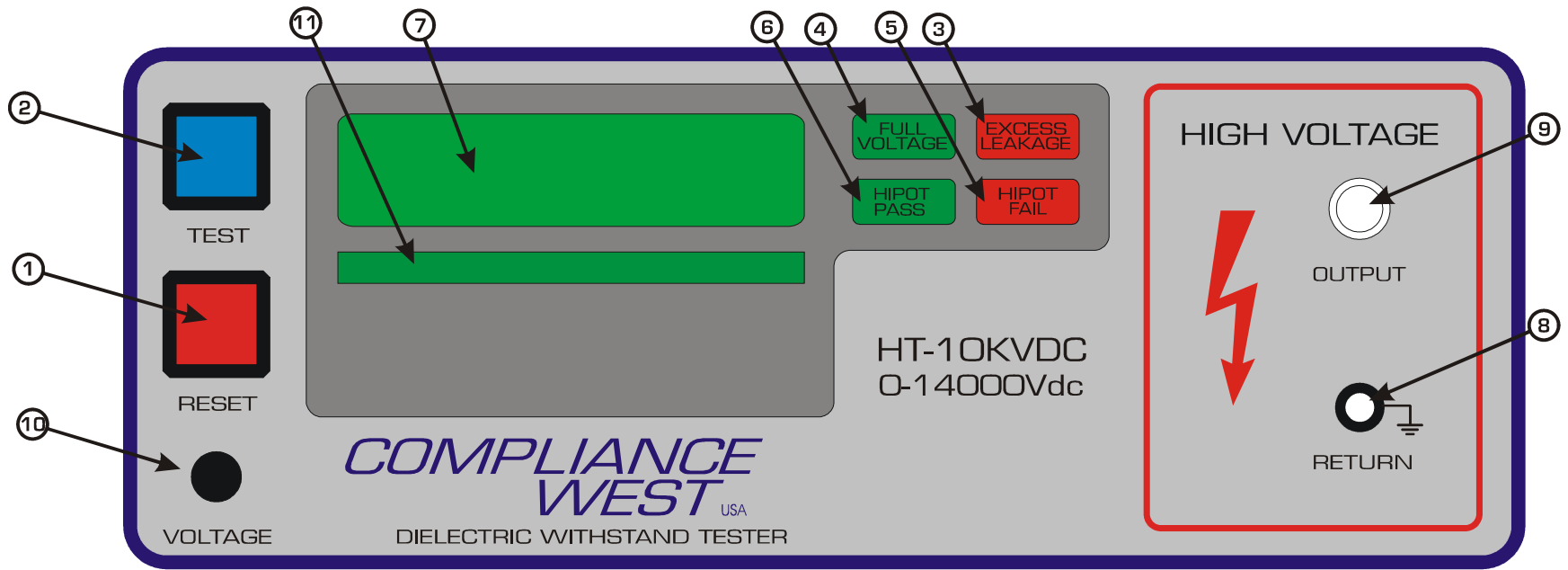
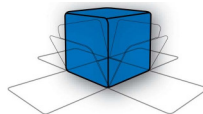
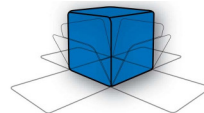

Figure 3-1. Controls, Indicators, Connectors - HT-10KVDC Front Panel



ITEM NO.	NAME	FUNCTION
1	RESET Button / Red Indicator Lamp	When lit, indicates that the HT-10KVDC is unarmed. This button must be pushed before the TEST Button is functional. When the RESET Button is pressed, the red lamp goes out and the blue TEST lamp is lit. PRESSING THE RESET BUTTON AT ANY TIME STOPS THE TEST. Replace lamp with type 73 T1¾ 14V lamp.
2	TEST Button / Blue Indicator Lamp	When lit, indicates that the HT-10KVDC is ready to test. The blue lamp goes out when the TEST Button is pressed. Replace lamp with type 73 T1¾ 14V lamp.
3	Excess Leakage LED	Indicates failure of leakage current test. If leakage current is too high, the red LED will light and the internal buzzer will sound. The test may be terminated, depending on the setting of the Failure Shutdown Switch.
4	Full Voltage LED	The full voltage LED will light and if not defeated, the high voltage duration time starts when the voltage output reaches the preset level.
5	Hipot Fail LED	Indicates failure of high voltage test. If arcing or a flashover of the insulation system is detected, the red breakdown LED will light, the internal buzzer will sound. The test may be terminated depending on the setting of the Failure Shutdown Switch.
6	Hipot Pass LED	At the preset test duration time, if no insulation breakdowns are encountered, the green light will light and the test will terminate. If the Test Timer Switch is defeated, testing continues only while the Test Button is pressed (minimum test time one second).
7	Voltage Meter	Visual indication of the actual output voltage.
8	Return Lead Jack	Grounded banana plug jack. For Return Lead connection.
9	High Voltage Output Jack	Red High Voltage jack. For connection of high voltage test lead.
10	Voltage Adjust Knob	Voltage is continuously adjustable during test.

Table 3-1. Controls, Indicators, Connectors - HT-10KVDC Front Panel



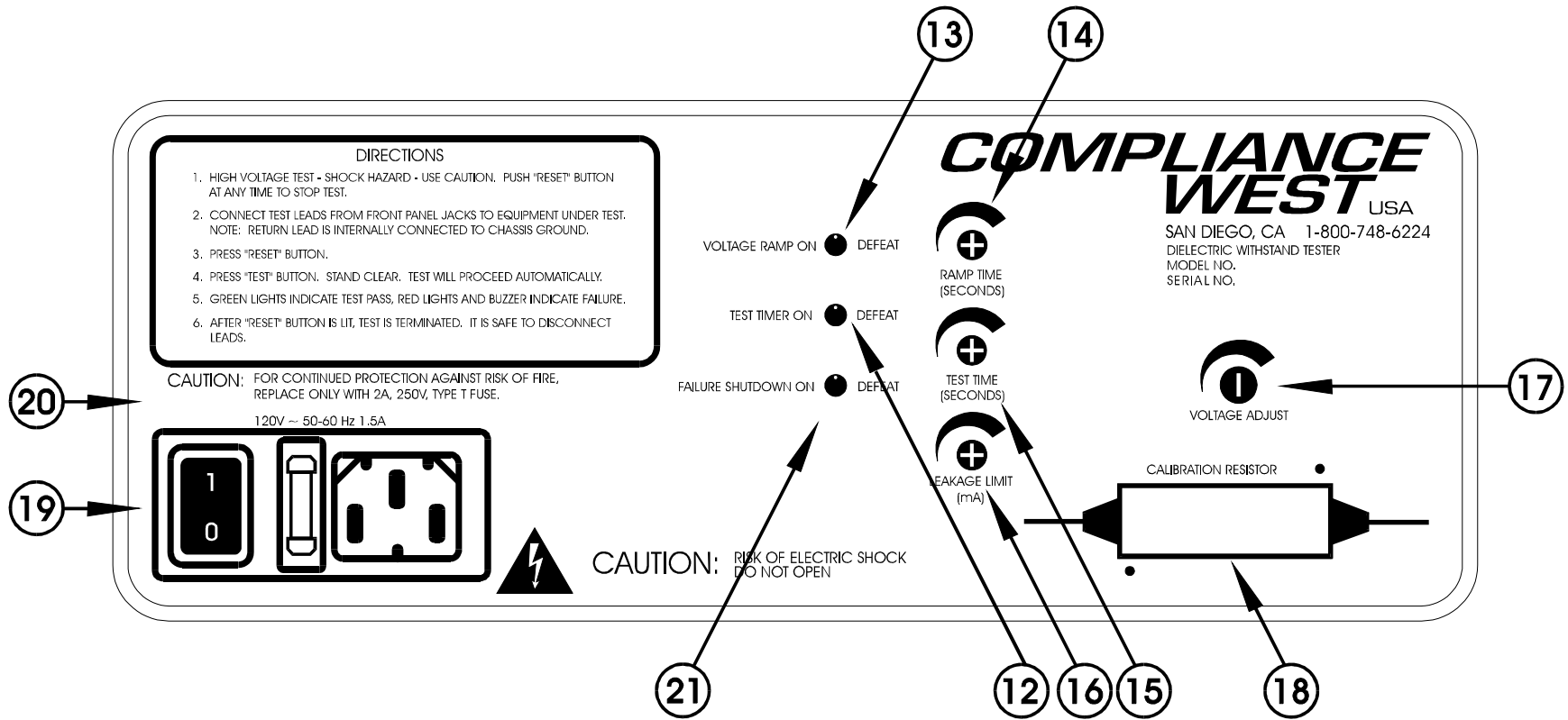
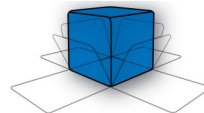
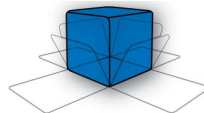

Figure 3-2. Controls, Indicators, Connectors - HT-10KVDC Rear Panel



ITEM NO.	NAME	FUNCTION
12	Test Timer Switch (not as shown)	When in ON position, test duration is as set by Test Time Adjustment, Item 15. When in DEFEAT position, test continues as long as TEST Button on front panel is pressed. Minimum test time is approximately one second.
13	Voltage Ramp Switch (not as shown)	When in ON position, high voltage rampup time is as set by Ramp Time Adjustment, Item 14. When in DEFEAT position, high voltage is applied immediately.
14	Ramp Time Adjustment	Adjusts the amount of time used to reach the correct high voltage output level. See "Adjustment of the High Voltage Ramp Time" section.
15	Test Time Adjustment	Adjusts the test duration. See "Adjustment of the High Voltage Test Duration" section.
16	Leakage Limit Adjustment	Adjusts the alarm level for the excessive leakage current test. See "Adjustment of the Leakage Current Level" section.
17	Voltage Adjust	Adjusts the High Voltage output. See "Adjustment of the High Voltage Level" section.
18	Calibration Resistor	Used in the Leakage Limit Adjustment procedure. See "Adjustment of the Leakage Current Level" section.
19	Appliance Inlet / Fuseholder / Power Switch	AC Input. Replace line fuse. Turn Tester ON/OFF.
20	Fuse replacement warning / Rating of supply	Specifies replacement fuse and supply voltage used.
21	Failure Shutdown Switch (not as shown)	When in ON position, a leakage or dielectric failure will terminate the test. When in DEFEAT position, test will continue.

Table 3-2. Control, Indicators, Connectors - HT-10KVDC Rear Panel



Initial Checkout Procedure

Use this procedure to verify that the HT-10KVDC is working correctly. This procedure should be conducted daily. Refer to Figures 3-1 and 3-2 for location of items.

CAUTION

High voltage. Risk of shock. Use care.

1. Turn the tester on using the rear panel switch; item 19.
2. Set the Voltage Ramp, Test Timer, and Failure Shutdown switches to ON; Items 12-13, and 21.
3. Disconnect leads from the Output and Return jacks; items 8 and 9.
4. Push the red RESET button; item 1. The blue TEST button will light; item 2.
5. Push the blue TEST button.
6. The tester will conduct a test sequence. The meter will show the output voltage, hold, and return to zero. During the test, the voltage can be adjusted using the Voltage knob; item 10. At the end of the test, the Full Voltage, Hipot pass, and red RESET lamps should be lit.
7. Connect the red lead to the Output jack; item 9, and the black lead to the Return jack, item 8.
8. Connect the two leads together. Push the RESET button and then push the TEST button.
9. At test termination, the Excess Leakage and/or Hipot Fail lamps; items 3 and 5, and red RESET lamps should be lit.
10. Disconnect the black lead from the red lead, and remove both leads from the HT-10KVDC.
11. Enable the voltage output by pressing the RESET button, then the TEST button. After the full voltage LED lights, adjust the Voltage knob; item 10, so the output is approx. 500 volts. Press the RESET button to stop the test.
12. Plug the red lead into the Output jack.
13. (This test simulates a dielectric breakdown. There is high voltage on the Red lead. Exercise caution to avoid shock.) Push the red RESET button, then the blue TEST button. After the full voltage LED lights, VERY CAREFULLY pick up the lead by its insulation and touch it to the Return jack. The test will immediately terminate with a buzzer. The Full Voltage, Hipot Fail and/or Excess Leakage, and red RESET lamps should be lit.

If any of these tests give unexpected results, service may be required. Please contact our Service hotline for assistance.

Setting up the HT-10KVDC for Laboratory Testing

This section describes procedures for setting the:

- a. leakage current level
- b. high voltage ramp time
- c. high voltage level
- d. high voltage test time
- e. voltage ramp switch
- f. test timer switch
- g. failure shutdown switch.

This will allow you to change settings from the factory settings below. Refer to Figures 3-1 and 3-2 for location of items.

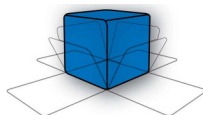

Factory Settings

The HT-10KVDC is configured as shown when shipped from Compliance West USA:

Leakage Current Level:	2 mA
High Voltage Ramp Time:	1 second
High Voltage Level:	0 volts
High Voltage Test Time:	2 seconds
Voltage Ramp Switch:	ON
Test Timer Switch:	ON
Failure Shutdown Switch:	ON

Adjustment of the Leakage Current Level

DC Leakage Current can be set to levels of up to 5 mA. Use the 120 kohm resistor and the leakage current adjustment control on the rear panel; items 16 and 18. Reset the high voltage level and test duration after this adjustment.

Since most controls used in this adjustment are on the rear panel, place the instrument so the rear panel faces you. Refer to Figures 3-1 and 3-2.

1. Determine the proper voltage setting for the desired leakage current level, using the formula: $\text{Volts} = (\text{Leakage Current in mA}) * (120)$
2. Adjust the Test Time control; item 15, on the rear panel to approximately the middle of its travel.
3. Adjust the Leakage Limit control; item 16, on the rear panel to its maximum clockwise position.
4. Make sure there are no test leads connected to the Tester.
5. Push the RESET button; item 1. The blue TEST light; item 2, should light, indicating that the Tester is ready to test.
6. Push the TEST button; item 2.
7. Use the Voltage Adjust control; item 10, to set the voltage calculated in Step 1 of this procedure, then push the RESET button.
8. Connect the red lead to the Output jack; item 9, and the black lead to the Return jack, item 8. Connect the alligator clips across the calibration resistor; item 18, on the rear panel.
9. Push the TEST Button; item 2, and then the RESET Button; item 1, repeatedly while decreasing the Leakage Limit; item 16. The lowest setting which lights the green Full Voltage light; item 4, is correct. If the red Excess Leakage light; item 3, lights instead, the adjustment is set too low.
10. You can pull the shaft out of the Leakage Limit control; item 16, if tamperproof settings are desired. It can be reinserted.
11. Reset the high voltage level and test duration before testing products. See the adjustment procedures below for reference.

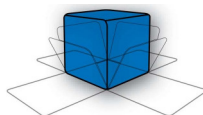

Adjustment of the High Voltage Ramp Time

This procedure sets the high voltage ramp time between 0.5 and 5 sec. The factory setting of one second is adequate for most situations. Refer to Figures 3-1 and 3-2 for location of items.

1. Make sure there are no test leads connected to the Tester.
2. Push the RESET button; item 1. The blue TEST light; item 2, should light, indicating that the Tester is ready to test.
3. Push the TEST button; item 2.
4. The voltage meter; item 7, will show the output voltage and hold. Use the Ramp Time control; item 14, to change the ramp time. Turning the control clockwise will increase ramp time, and turning it counterclockwise will decrease it.
5. Push the TEST button; item 2, and RESET button; item 1, repeatedly, changing the Ramp Time; item 14, until the desired value is reached.
6. You can pull the shaft out of the Ramp Time control if tamperproof settings are desired. It can be reinserted.

Adjustment of the High Voltage Level

This procedure controls the high voltage level used in the dielectric withstand test. The HT-10KVDC is factory set for 0 volts DC. Use the procedure below to set it.

1. Turn the Test Timer switch; item 12, to the DEFEAT position. (The HT-10KVDC will supply voltage while the TEST button; item 2, is held in.)
2. Make sure there are no test leads connected to the HT-10KVDC.
3. Press the RESET button; item 1. The blue TEST light; item 2, should light, indicating that the HT-10KVDC is ready to test.
4. Push and hold the TEST button; item 2.
5. While the TEST button is pressed, the voltage will ramp. Adjust the high voltage control; item 10, until the desired voltage is reached.

Adjustment of the High Voltage Test Duration

This procedure sets the amount of time the tester will conduct the high voltage test. The test duration of the HT-10KVDC is factory set for 2 seconds. If a different test duration is required, use this procedure to set it.

1. Make sure there are no test leads connected to the tester. Set all three rear panel switches "ON".
2. Push the RESET button; item 1. The blue TEST light; item 2, should light, indicating that the Tester is ready to test.
3. Push the TEST button; item 2.
4. The Full Voltage LED; item 4, will light. The test time is from when the Full Voltage LED lights to the end of the test.
5. After the test is complete, adjust the Test Time control; item 15.
6. Push the RESET Button; item 1, then the TEST Button; item 2, and time the new test duration. Adjust the Test Time control until correct.

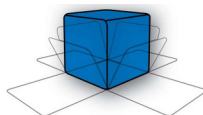

Setting the Voltage Ramp Switch

The Voltage Ramp switch; item 13, is used to ramp up the voltage, or to immediately apply full high voltage to the circuit being tested.

When this switch is in the DEFEAT position, the voltage will immediately rise to the level set by the Voltage knob; item 10. The Ramp Time setting; item 14, is ignored.

When this switch is in the ON position, the voltage ramps according to the setting of the Ramp Time control; item 14. See adjustment instructions above.

The Voltage Ramp must be DEFEAT if Failure Shutdown Defeat is desired. See Table 3-3 for details.

Setting the Test Timer Switch

The Test Timer Switch; item 13, allows test time to be controlled by the HT-10KVDC's internal timer or to continue until terminated by the operator.

When this switch is in the DEFEAT position, the test will continue only while the TEST button; item 2, is pushed. The minimum test time is approx. 1 second.

When this switch is in the ON position, the test time will be controlled by the HT-10KVDC's internal timer. For information on how to set this time, see instructions above.

The Test Timer must be defeated if Failure Shutdown Defeat is desired. See Table 3-3 for details.

Setting the Failure Shutdown Switch

The Failure Shutdown Switch; item 21, allows the operator to continue testing after a failure is encountered. This allows the operator to find a breakdown point, but **all safety shutdown circuitry in the HT-10KVDC is disabled when the Failure Shutdown switch is in the DEFEAT position.** Tests may be terminated at any time by pressing the RESET button.

When the Failure Shutdown switch is in the DEFEAT position, the test continues while the TEST button; item 2, is held down (minimum duration 1 second). This allows the operator to find insulation breakdowns easily.

When the Failure Shutdown switch is in the ON position, the HT-10KVDC will stop the test when excessive leakage or a high voltage arc is detected. Leave the Failure Shutdown switch in the ON position for normal testing.

WARNING: Testing with the Failure Shutdown switch in the DEFEAT position is extremely hazardous. The HT-10KVDC can generate lethal levels of voltage and current. Therefore, care should be taken in examining the equipment being tested to locate areas of failure while the HT-10KVDC is operating. Do not operate the HT-10KVDC for extended periods under conditions of excess leakage or dielectric failure, as overheating and/or damage to the equipment being tested may result.

Operating Techniques

The following paragraphs describe how to operate the HT-10KVDC Dielectric Withstand Tester.

CAUTION

High voltage is generated by the HT-10KVDC. Although the chassis of the equipment under test is grounded by the HT-10KVDC, a risk of shock exists. Exercise care when using the HT-10KVDC.



Daily Operation Test

The operation of the HT-10KVDC should be checked daily by conducting the tests described in the **Initial Checkout Procedure** section of this Manual.

Testing Products

This section describes how to conduct a test. Testing can be terminated at any time by pressing the red RESET button; item 1.

1. Connect your Tester to a correctly rated source of supply and turn it on.
2. Plug the black lead into the Return jack; item 8. Plug the red lead into the Output jack; item 9.
3. Connect the alligator clips of the leads across the circuit or part being tested. Keep in mind that the black lead is connected to earth ground.
4. Press the RESET button; item 1. The blue TEST light; item 2, should light, indicating that the HT-10KVDC is ready to test.
5. Push the TEST button, item 2. The HT-10KVDC will either:
 - Ramp the voltage at the rate set by the Ramp Time Procedure, if the Voltage Ramp Switch; item 13, is set to DEFEAT.
 - Immediately energize the high voltage output if the Voltage Ramp Switch is set to DEFEAT.
6. • If the Failure Shutdown Switch; item 21, is ON, and if the leakage current of the circuit under test is too high, the Excess Leakage LED; item 3, will light, and the test will terminate.
 - If the Failure Shutdown Switch is set to DEFEAT, and the requirements of Table 3-3 are met, the HT-10KVDC will continue to test. Voltage output may sag if the power required by the circuit is beyond the capabilities of the HT-10KVDC.
7. • If the Test Timer Switch; item 12, is ON, the HT-10KVDC will conduct the high voltage test for the amount of time set in the Test Duration procedure.
 - If the Test Timer Switch is set to DEFEAT, the high voltage test will continue only while the TEST button; item 2, is pressed.
8. If a insulation system breakdown is detected, and
 - The Failure Shutdown Switch; item 21, is ON, the voltage will ramp down to a safe level, the Hipot Fail LED; item 5, will light, the buzzer will sound, and the test will terminate.
 - The Failure Shutdown Switch is set to DEFEAT, and the requirements of Table 3-3 are met, the Hipot Fail LED will light and the test will continue.
9. If no breakdown is detected, the high voltage will ramp down, the Hipot Pass LED; item 6, will light, and the red RESET switch; item 1, will light.
10. Do not disconnect the leads from the equipment being tested until the Hipot Pass or Hipot Fail light has lit, and the meter indicates less than 50 volts.

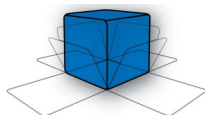

Test results

Hipot Pass: If the Hipot Pass light is lit, the equipment being tested passed all test parameters.

Red LED/Buzzer: Any red LED/buzzer test result means the equipment being tested failed a test phase. If unanticipated test failures continue, and you suspect that the equipment under test is built correctly, check the following item:

1. If the Leakage Current level is at its highest setting and failures continue, check the circuit being tested with an ohmmeter; it may be shorted.

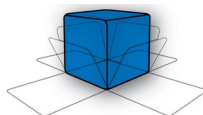

Voltage Ramp	ON	DEFEAT	ON	DEFEAT	DEFEAT
Test Timer	ON	ON	DEFEAT	DEFEAT	DEFEAT
Failure Shutdown	ON	ON	ON	ON	DEFEAT
See Below	A	B	C	D	E

Table 3-3: Rear Panel Switch Truth Table

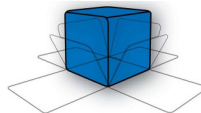

A	Fully automatic operation. When Test button is pressed, the output voltage will ramp at a rate determined by the position of the TEST TIME adjustment knob. Test will stop automatically on all leakage or breakdown failures.
B	Voltage Ramp is defeated. Same as (A) above except that full voltage is produced at the output immediately. Test will stop automatically on all leakage or breakdown failures. For safety, we recommend that you begin testing with the front panel voltage knob set at minimum.
C	Test Timer is defeated. Same as (A) above except that after full voltage is reached, the test will continue only as long as the Test button is held in, minimum one second. Test will stop automatically on all leakage or breakdown failures.
D	Voltage Ramp and Test Timer are defeated. Full voltage is produced at the output immediately when the Test button is pressed. The test will continue only as long as the Test button is held in, minimum one second. Test will stop automatically on all leakage or breakdown failures. For safety, we recommend that you begin testing with the front panel voltage knob set at minimum.
E	Total Defeat. Full voltage is produced at the output immediately. Test will continue only as long as the TEST button is held in, minimum one second. The HT-10KVDC will not shut down on a leakage or dielectric failure, but the front panel Excess Leakage or Hipot Fail lights will indicate a failure. The Hipot Pass light will not light at the completion of a successful test. For safety, we recommend that you begin testing with the front panel voltage knob set at minimum. WARNING: Testing with the shutdown defeated is extremely hazardous. The HT-10KVDC can generate lethal levels of voltage and current. Therefore, care should be taken when examining the equipment being tested to locate areas of failure while the HT-10KVDC is operating. Do not operate the HT-10KVDC for extended periods under conditions of excess leakage or dielectric breakdown, as overheating and/or damage to the equipment being tested may result.
NOTE	All undefined states will inhibit HT-10KVDC operation. Buzzer will sound.

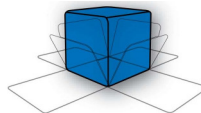

Section 4

Technical Assistance

For Technical Assistance

Phone: (800) 748-6224

Technical Assistance is available from Compliance West USA between the hours of 8:30 AM and 4:30 PM Pacific Time.

Compliance West USA

2120 Jimmy Durante Blvd., Suite 118

Del Mar, CA 92014

Phone: (858) 481-6454

FAX: (858) 481-8527

info@compwest.com

www.compwest.com

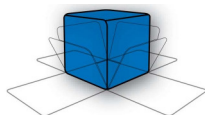

Section 5

Maintenance and Calibration

WARNING

THESE SERVICE INSTRUCTIONS ARE FOR USE BY QUALIFIED PERSONNEL ONLY. TO AVOID ELECTRIC SHOCK, DO NOT PERFORM ANY SERVICING OTHER THAN THAT CONTAINED IN THE OPERATING INSTRUCTIONS UNLESS YOU ARE QUALIFIED TO DO SO.

This section of the manual contains maintenance information for the Model HT-10KVDC Dielectric Withstand Tester. This maintenance information is divided into service information, general maintenance, a performance test, and a calibration procedure. The performance test is recommended as an acceptance test when the instrument is first received, and later as a preventative maintenance tool to verify proper instrument operation. A 1-year calibration cycle is recommended to maintain the specifications given in Section 1.

No test equipment is required to conduct the performance test.

The test equipment required for the calibration procedure is a DMM able to read true rms 0-14000 Vdc \pm 1%.

Service Information

The HT-10KVDC is warranted to the original purchaser for a period of 1 year. This warranty does not cover problems due to misuse or neglect.

Malfunctions which occur within the limits of the warranty will be corrected at no charge. Mail the instrument post paid to the manufacturer. Dated proof of purchase is required for all in-warranty repairs.

The manufacturer is also available for calibration and / or repair of instruments that are beyond their warranty period. Contact the manufacturer for a cost quotation. Ship the instrument and your remittance according to the instructions given by the manufacturer.

General Maintenance

Calibration Access

Use the following procedures to gain access to the calibration adjustments of your instrument.

1. Set Line Power switch to OFF.
2. Disconnect the power cord from the rear of the instrument.
3. Remove the two upper screws on each side of the unit.
4. Grasp the top of the enclosure clamshell and lift it off the front and rear panels.
5. All calibration adjustments are now accessible.

WARNING

Dangerous voltages exist when energized. Exercise extreme care when working on an energized circuit.

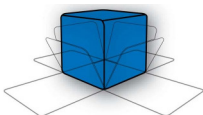

6. To reassemble, reverse steps 1-6 above.

Cleaning

Clean the front panel and case with a mild solution of detergent and a damp sponge. Clean dust from the PWB with clean, dry, low pressure (<20 psi).

Performance Test

The performance test evaluates the performance of your instrument to ensure that the logic, lights and high voltage sections are working properly. This test is recommended for incoming inspection, as a preventative maintenance check, and to verify proper operation during the calibration procedure. It is not necessary to disassemble the instrument to conduct these tests. If the instrument fails any part of the performance test, calibration and / or repair is indicated.

Allow the instrument to stabilize and perform the test at an ambient temperature of $23^{\circ}\text{C} \pm 5^{\circ}\text{C}$ ($73^{\circ}\text{F} \pm 9^{\circ}\text{F}$).

Operation/Lamp Function Test

Use this procedure to verify that the HT-10KVDC is working correctly. This procedure should be conducted daily. Refer to Figures 3-1 and 3-2 for location of items.

CAUTION

High voltage. Risk of shock. Use care.

1. Turn the Tester on using the rear panel switch; item 19.
2. Set the Voltage Ramp, Test Timer, and Failure Shutdown switches to ON; Items 12-13, and 21.
3. Disconnect leads from the Output and Return jacks; items 8 and 9.
4. Push the red RESET button; item 1. The blue TEST button will light; item 2.
5. Push the blue TEST button.
6. The Tester will conduct a test sequence. The meter will show the output voltage, hold, and return to zero. During the test, the voltage can be adjusted using the Voltage knob; item 10. At the end of the test, the Full Voltage, Hipot pass, and red RESET lamps should be lit.
7. Connect the red lead to the Output jack; item 9, and the black lead to the Return jack, item 8.
8. Connect the two leads together. Push the RESET button and then push the TEST button.
9. At test termination, the Excess Leakage and/or Hipot Fail lamps; items 3 and 5, and red RESET lamps should be lit.
10. Disconnect the black lead from the red lead, and remove both leads from the HT-10KVDC.
11. Enable the voltage output by pressing the RESET button, then the TEST button. After the full voltage LED lights, adjust the Voltage knob; item 10, so the output is approx. 500 volts. Press the RESET button to stop the test.
12. Plug the red lead into the Output jack, and the black lead into the Return jack.
13. (This test simulates a dielectric breakdown. There is high voltage on the Red lead. Exercise caution to avoid shock.) Push the red RESET button, then the blue TEST button. After the full voltage LED lights, VERY CAREFULLY pick up the Black lead by its insulation and touch it to the alligator clip on the end of the red lead. The test will immediately terminate

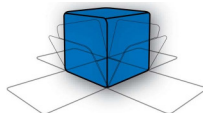

with a buzzer. The Full Voltage, Hipot Fail and/or Excess Leakage, and red RESET lamps should be lit.

With the exception of lamp replacement of the TEST and RESET buttons with type 73 14 volt lamps, if the results of the performance test are not in accordance with the above, service is required. Remove the Tester from service and contact the manufacturer for servicing information.

Calibration Procedure

The Calibration Procedure should be used any time your instrument has been repaired or fails to pass the performance test. The calibration procedure consists of the following:

- The Voltage Calibration adjustment calibrates the voltage output to agree with the meter reading.

Before starting the Calibration procedure, perform the Calibration access procedure given earlier in this Section.

NOTE

Allow the instrument to stabilize for approximately five minutes. Perform all calibration adjustments at an ambient temperature of $23^{\circ}\text{C} \pm 5^{\circ}\text{C}$ ($73^{\circ}\text{F} \pm 9^{\circ}\text{F}$).

WARNING

CALIBRATION ADJUSTMENTS ARE PERFORMED ON ENERGIZED CIRCUITS. EXERCISE CAUTION AT ALL TIMES, AND USE A NON-CONDUCTIVE TOOL FOR ALL ADJUSTMENTS.

Meter Calibration Adjustment

Use the following procedure to calibrate the output voltage. Pot R326 is located on the lower PWB, in the left front corner, and is used to adjust the meter reading.

1. Ensure that all test leads are removed.
2. Connect the DMM between the red high voltage jack and the black return jack. Both jacks are located on the front panel.
3. Push the RESET, then the TEST Button on the front panel. Wait for the full voltage LED on the front panel to light. Read the voltage on the DMM and compare it to the front panel meter. Using a non-conductive screwdriver, adjust R326 to bring both meters into agreement. If necessary, the Test Time control on the rear panel may need to be increased to allow the test to continue for a sufficient time.

